

Trim As Required

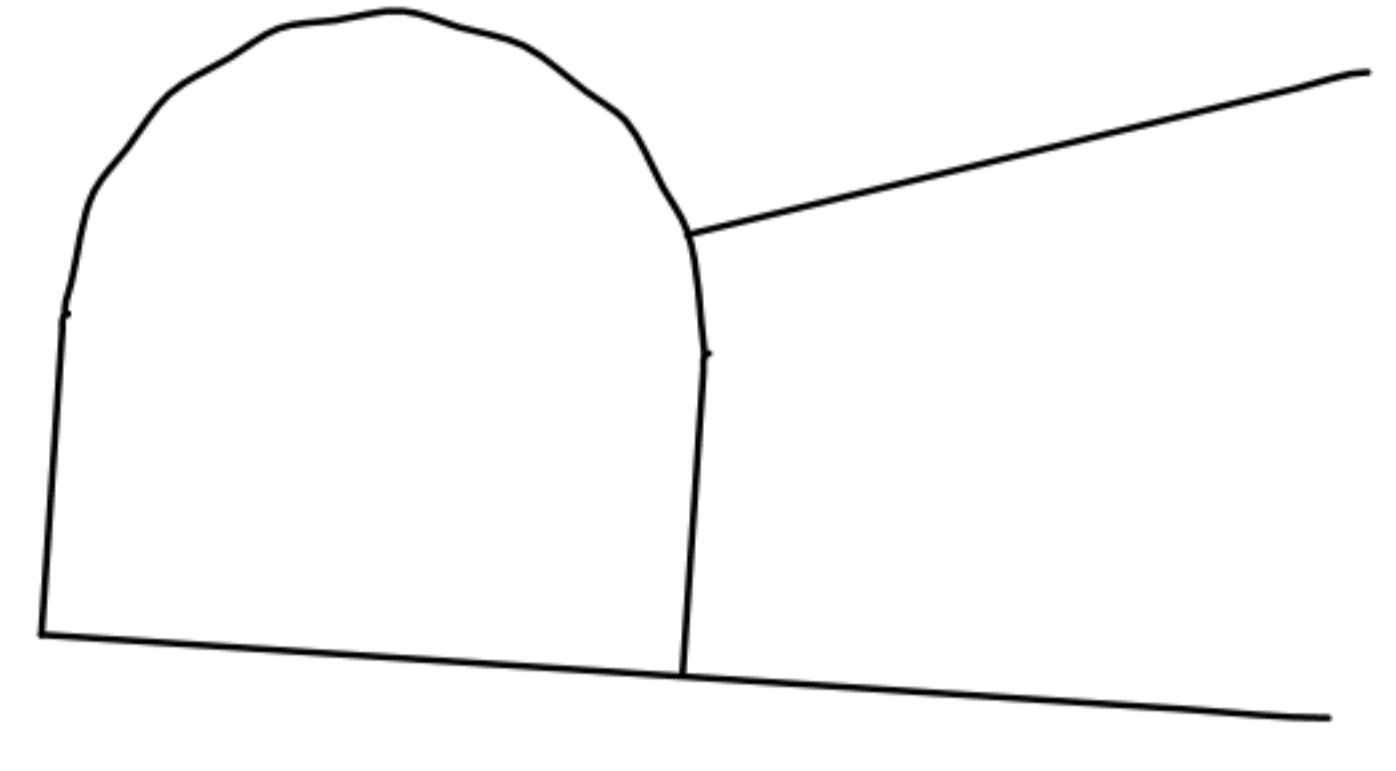

Trim As Required

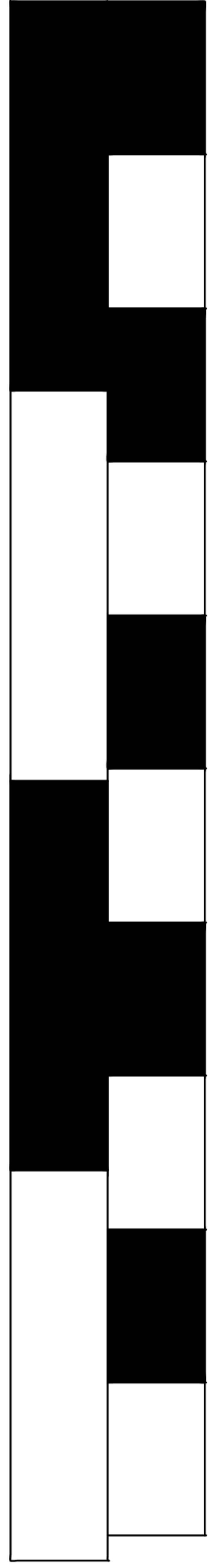

Trim As Required

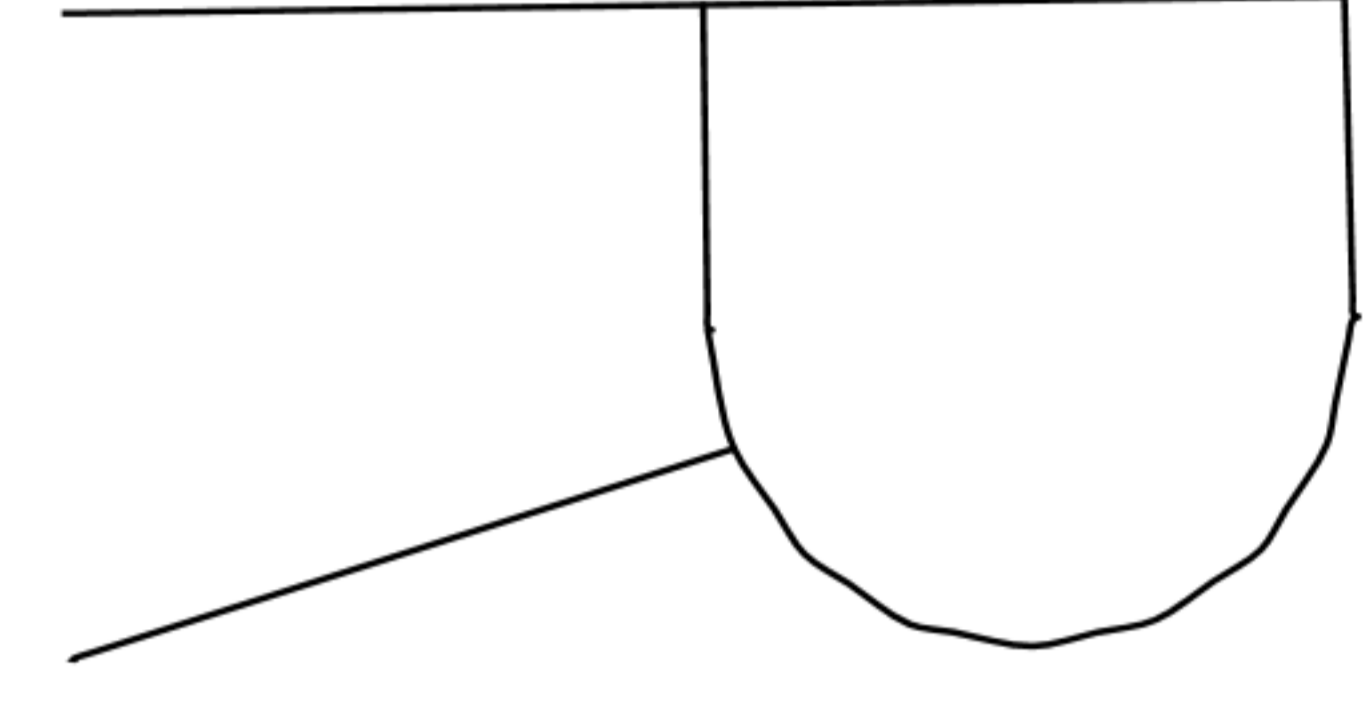

Trim As Required

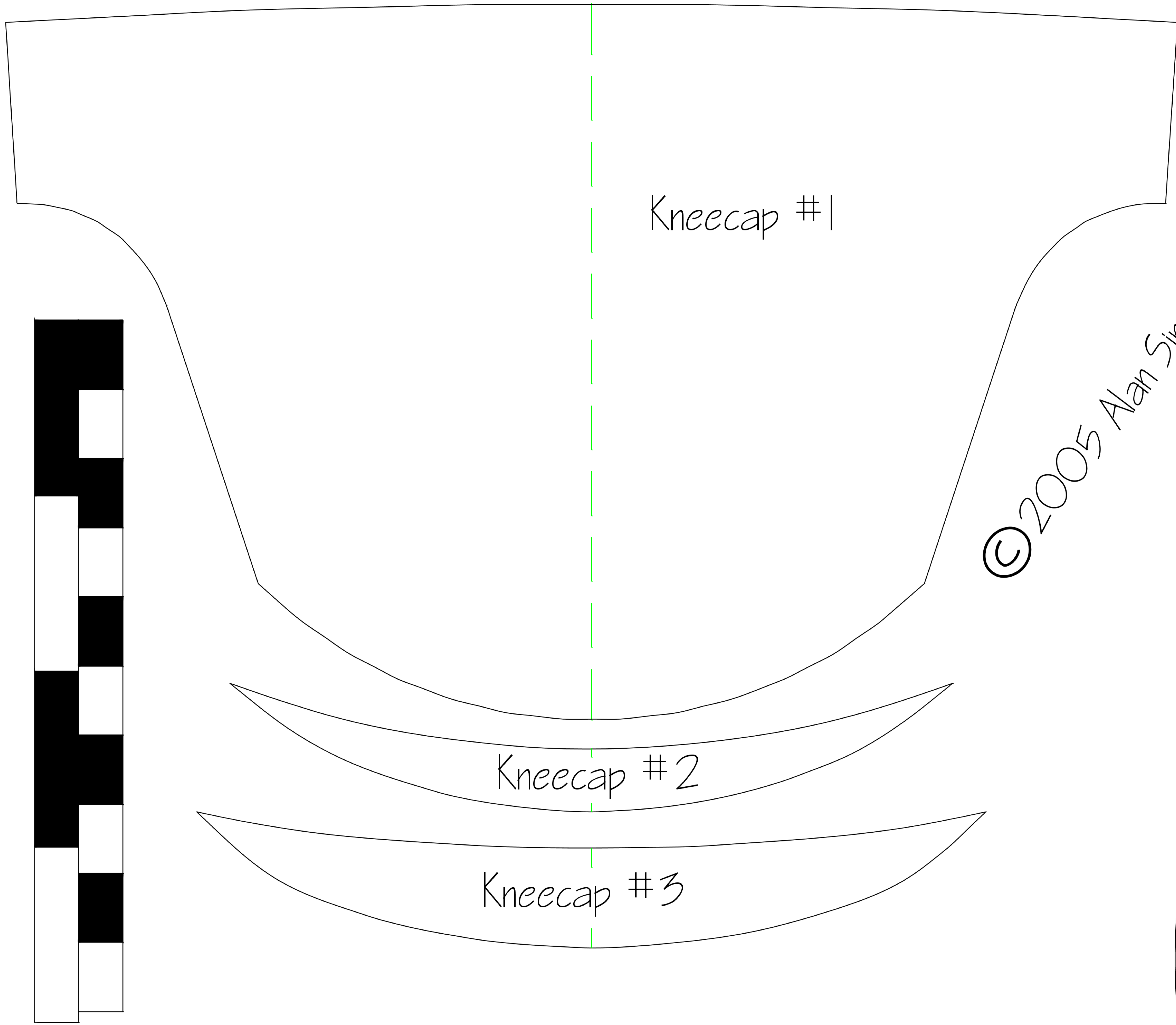

Knee Darts 3 RQD

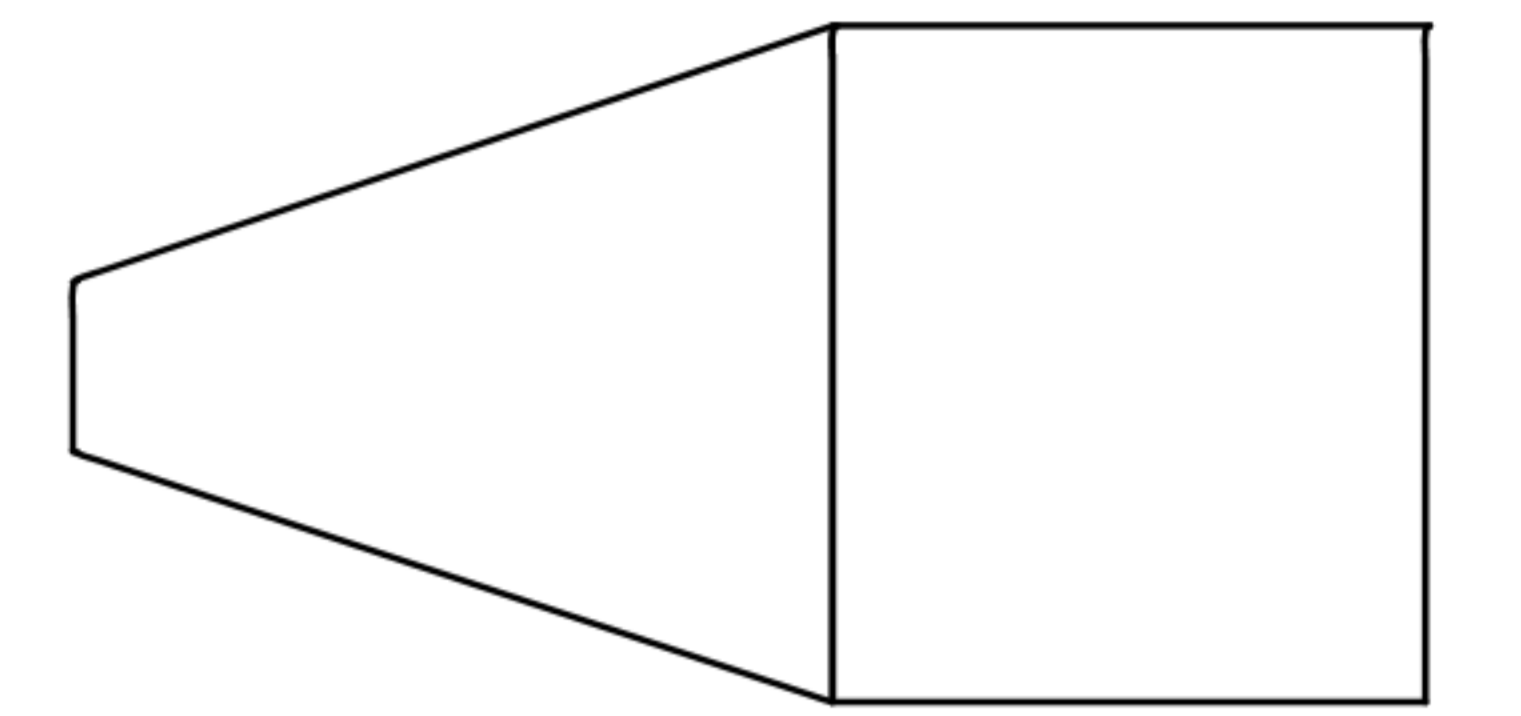
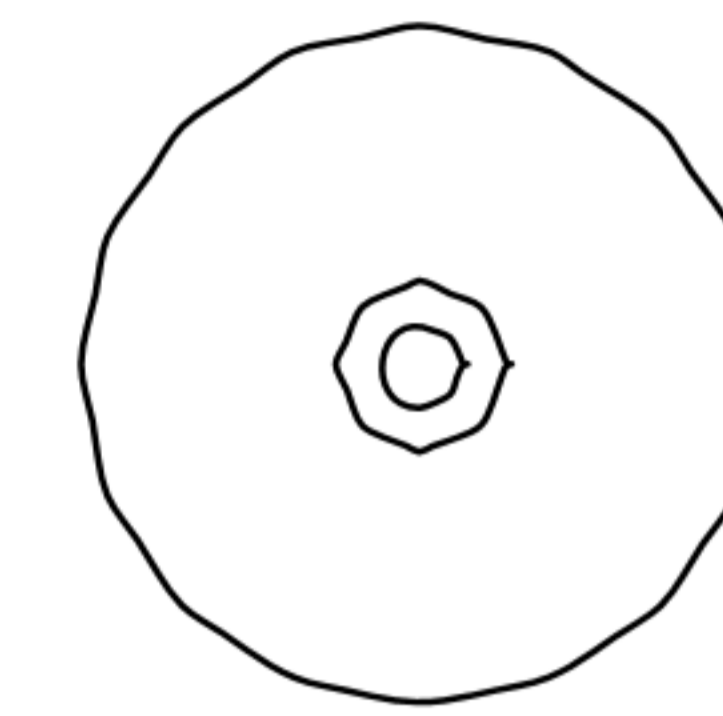
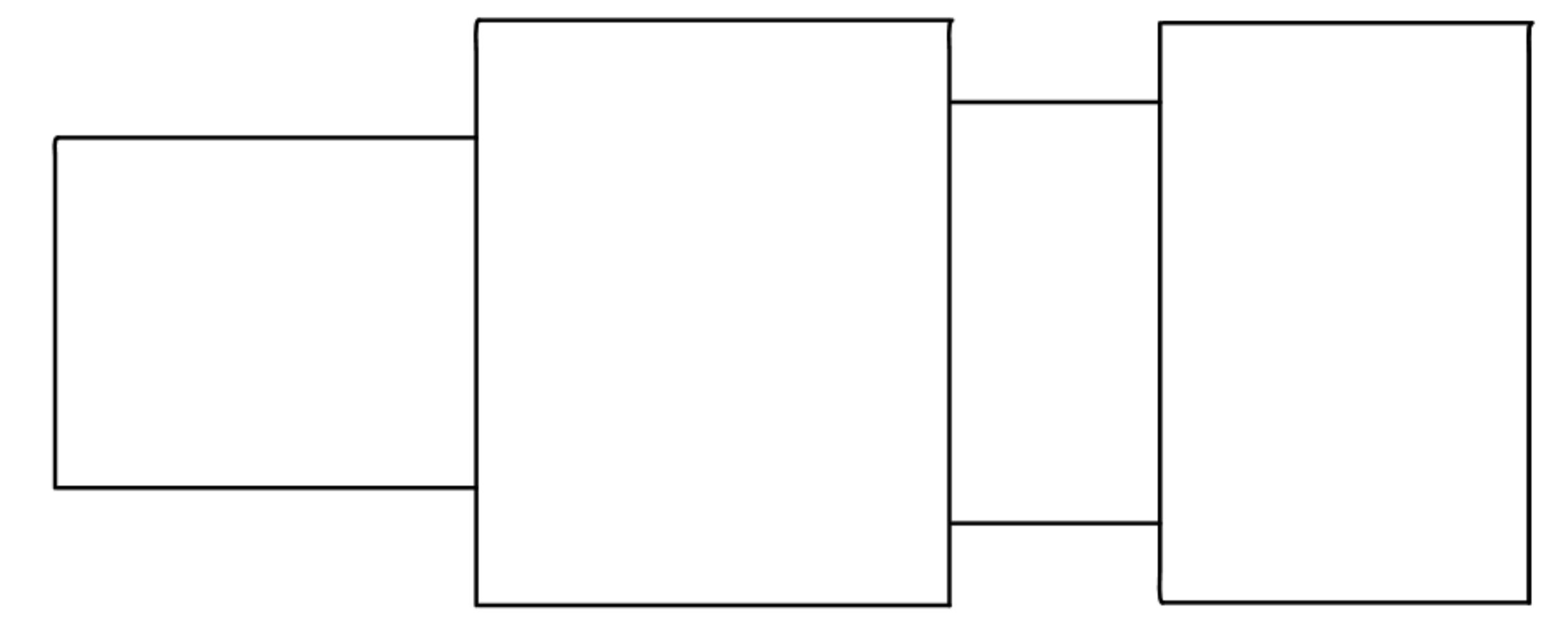
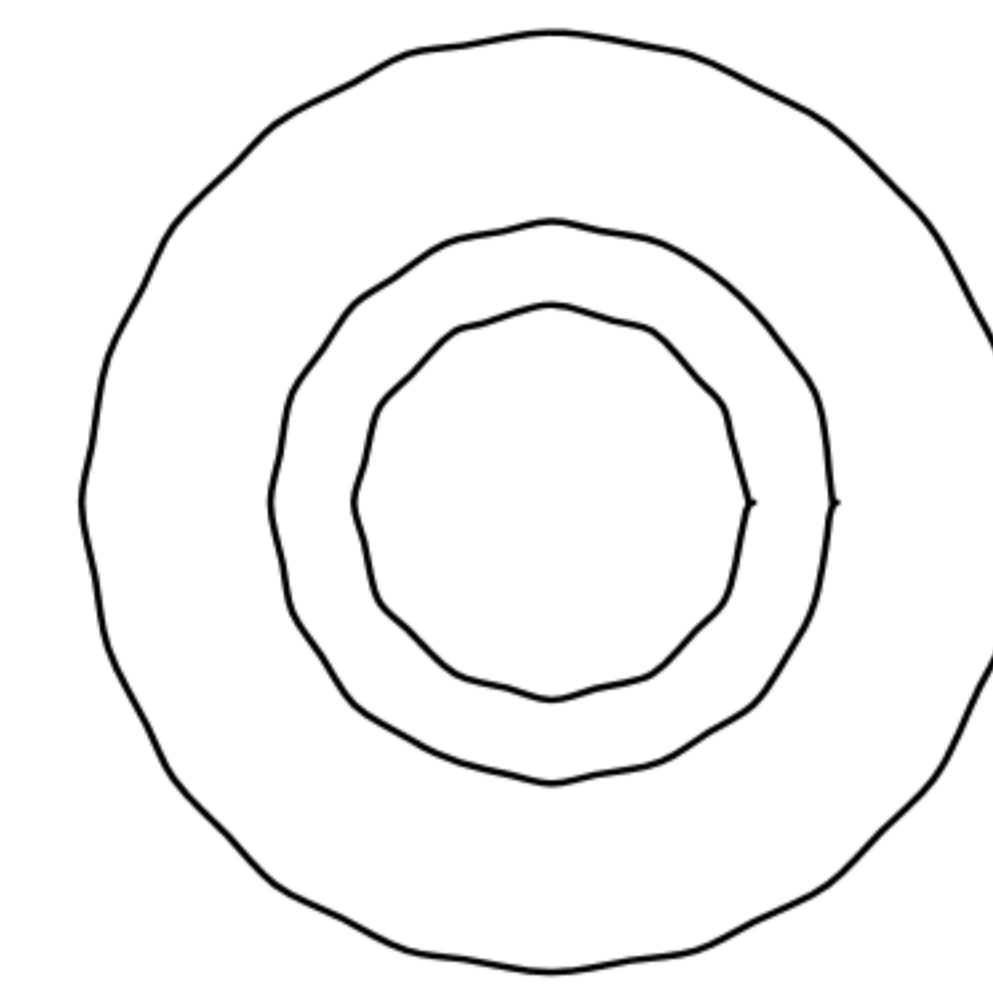

Knee Dart 1 RQD

© 2005 Alan Sinclair

Kneecap #2

Kneecap #3

Front Face

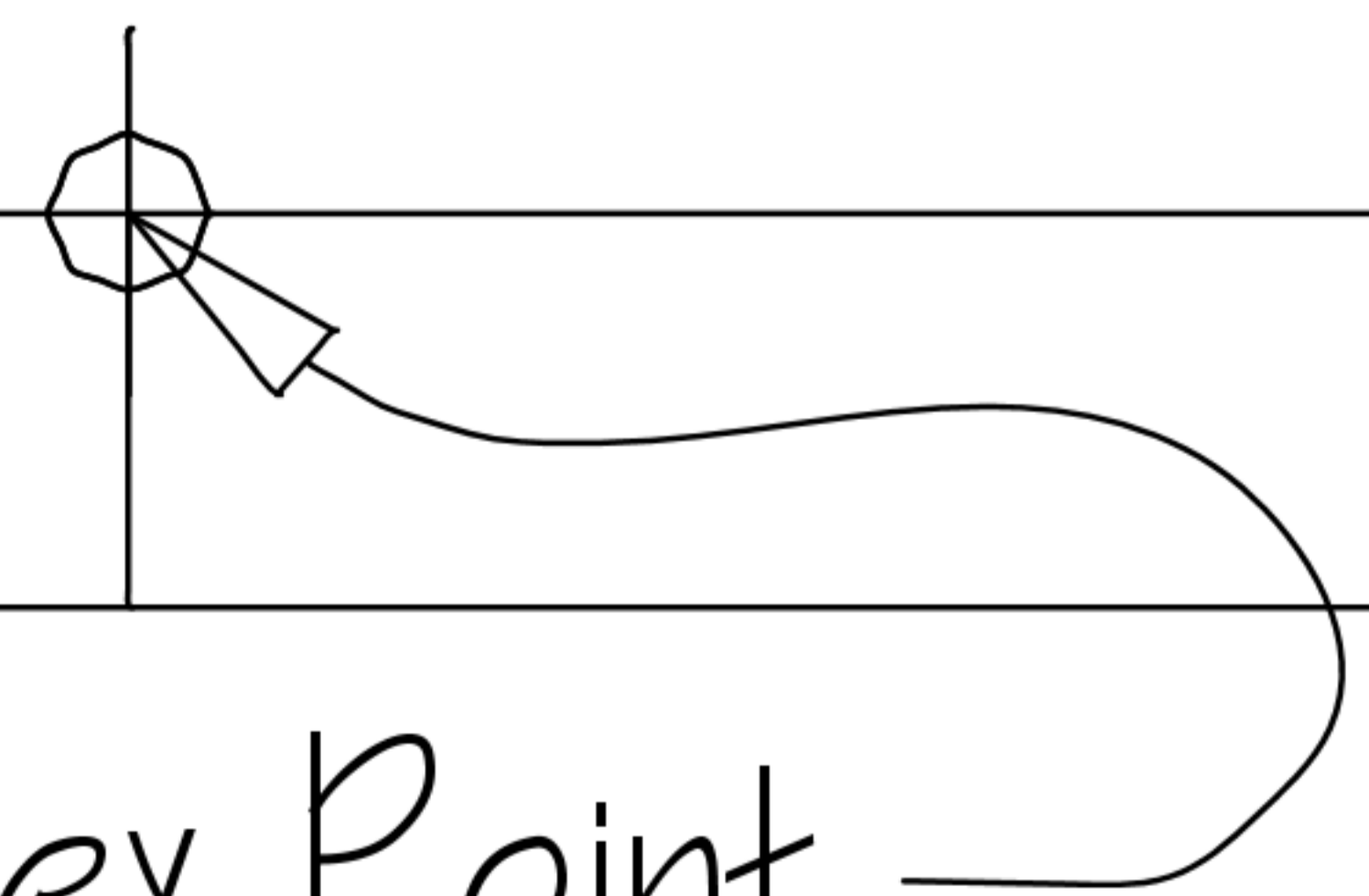

Knee Dart Block Index Point

Laminate Layers and Sand to Shape

2 Blocks RQD

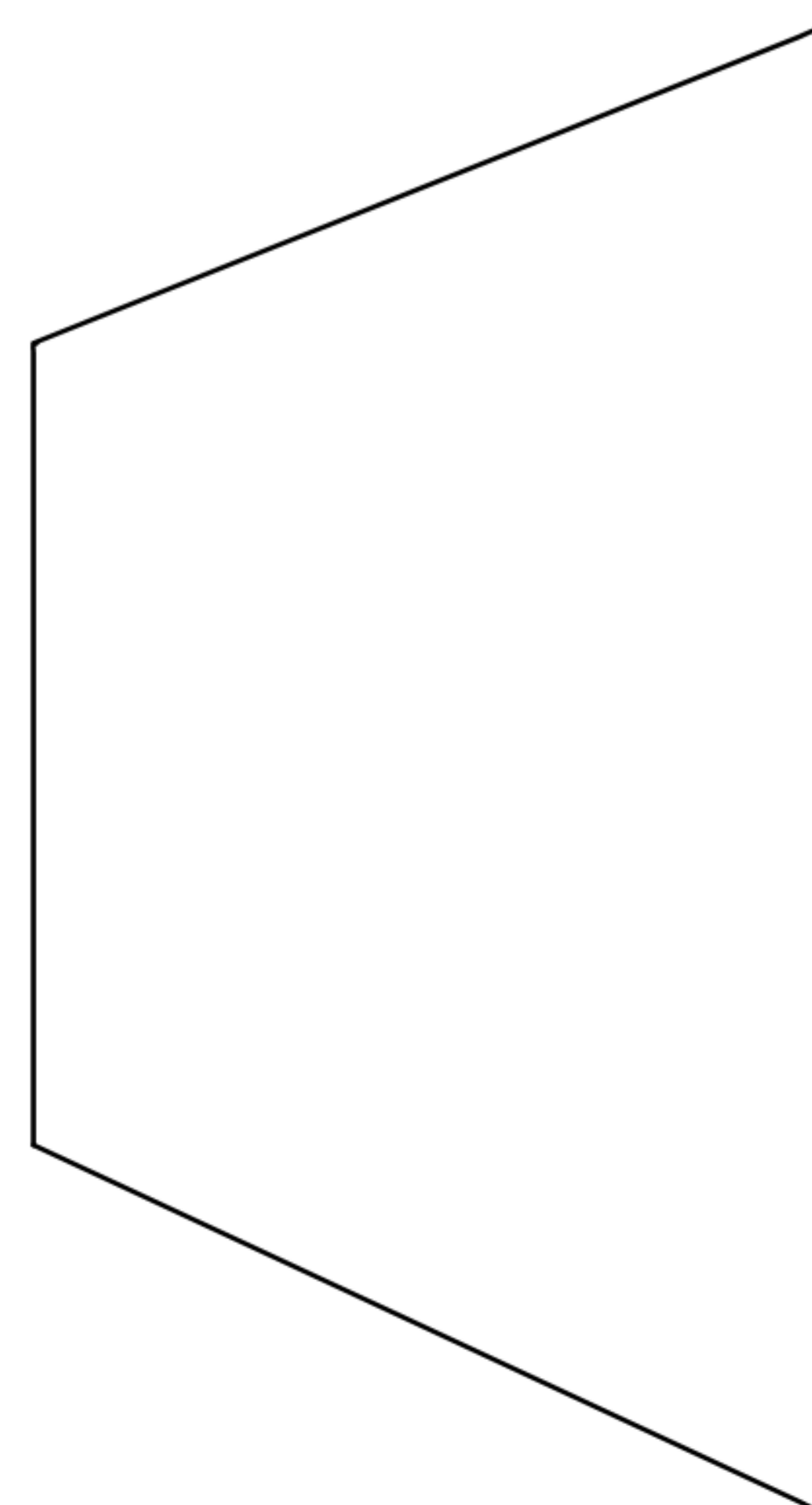

JIS



Dart Blocks can be made from wood or laminated from layers of Sintra and then sanded to the final shape.

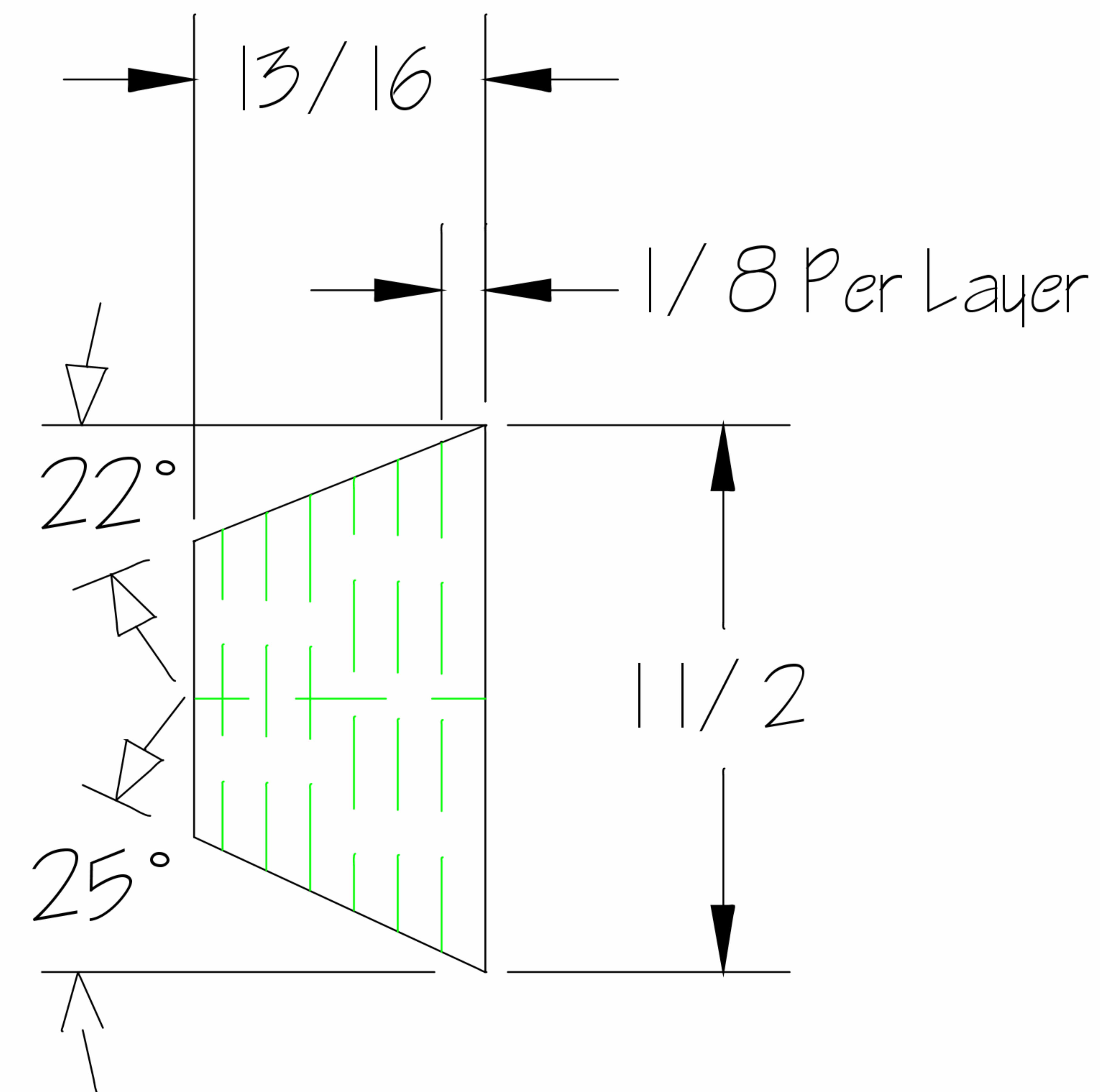
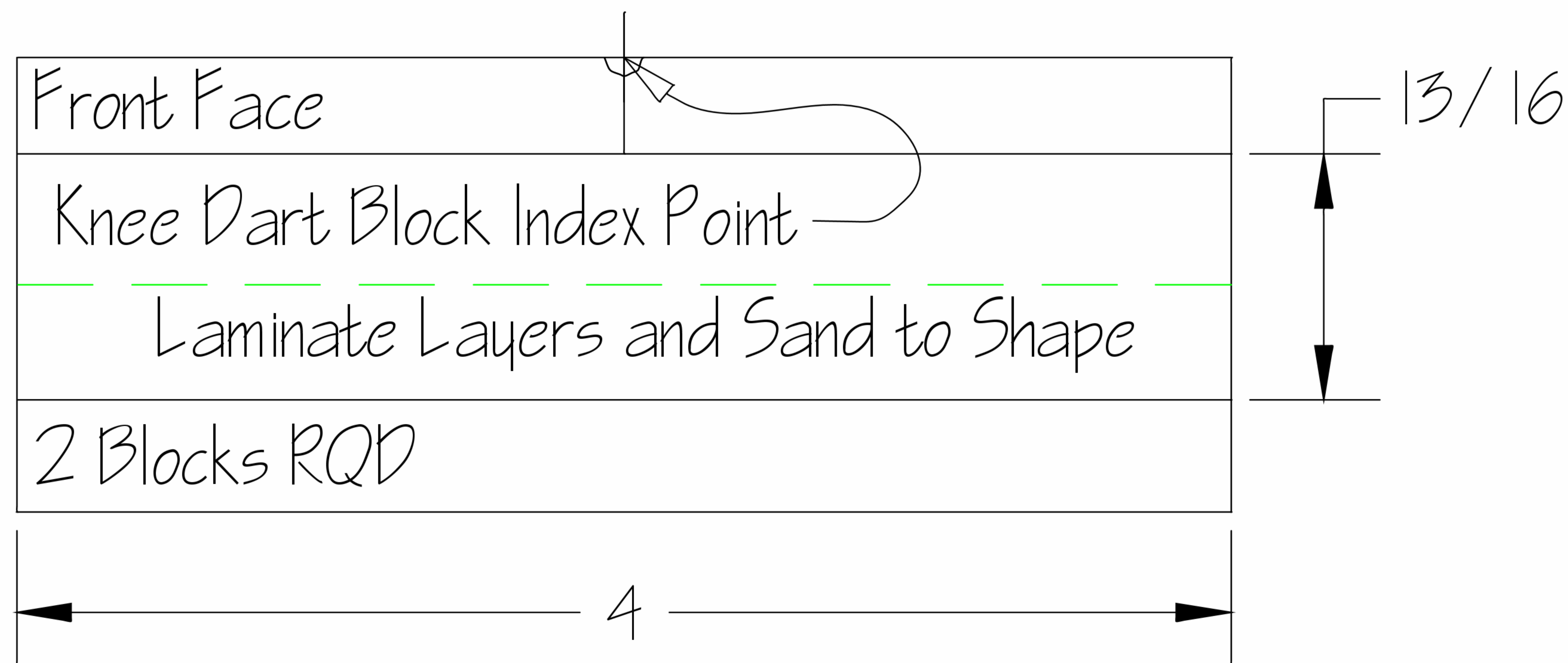

Knee Dart Block  
Drill & Shaping  
Templates

Right Knee  
Dart Block  
Template

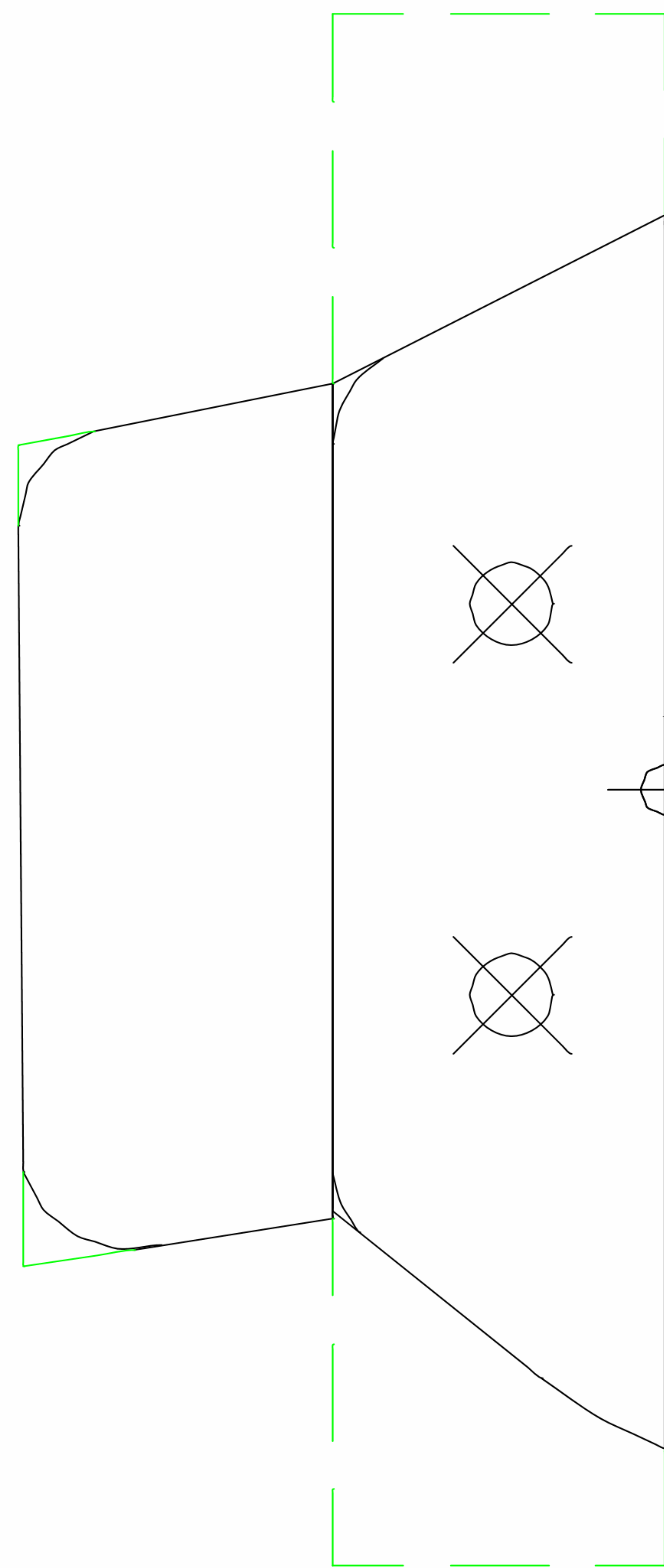

Knee Dart Block  
Index Point

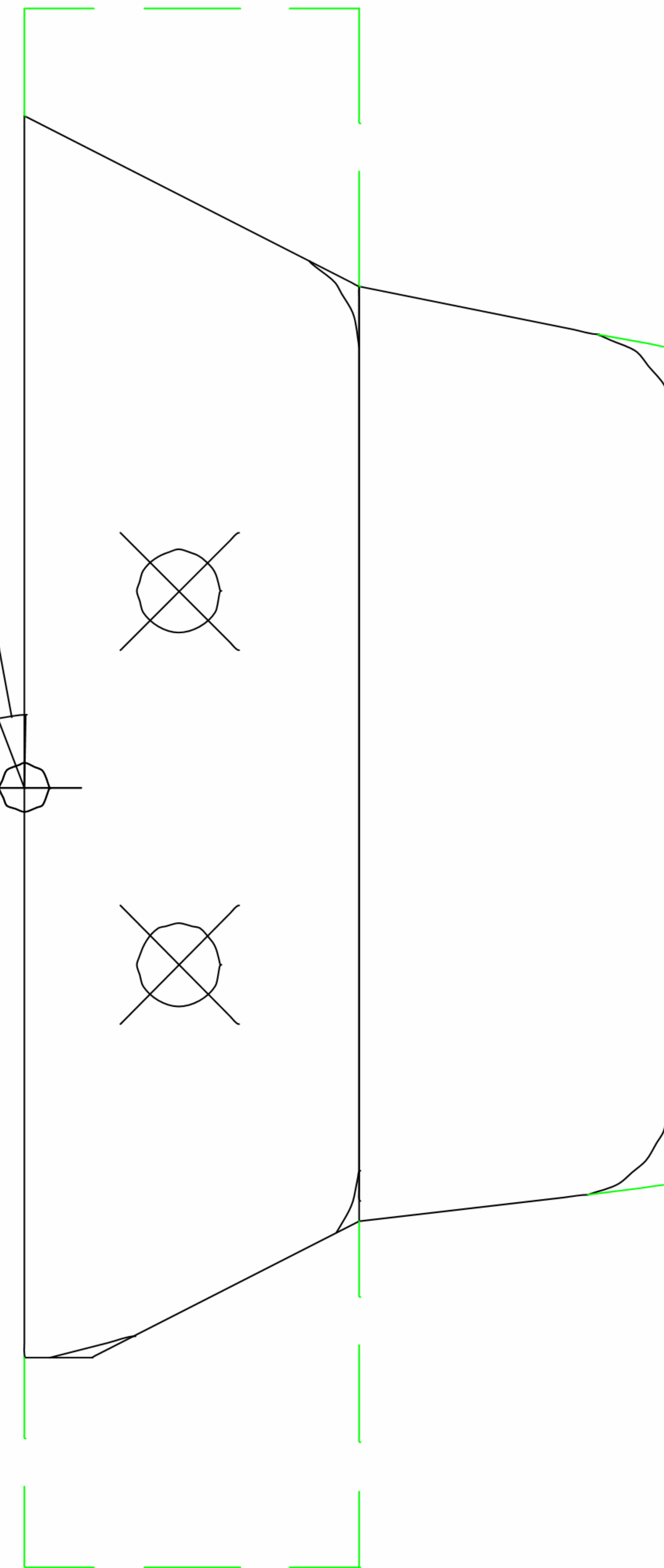

Left Knee  
Dart Block  
Template

